

White Connectors shown for Depth only.
Dimension/Locations Not exact.

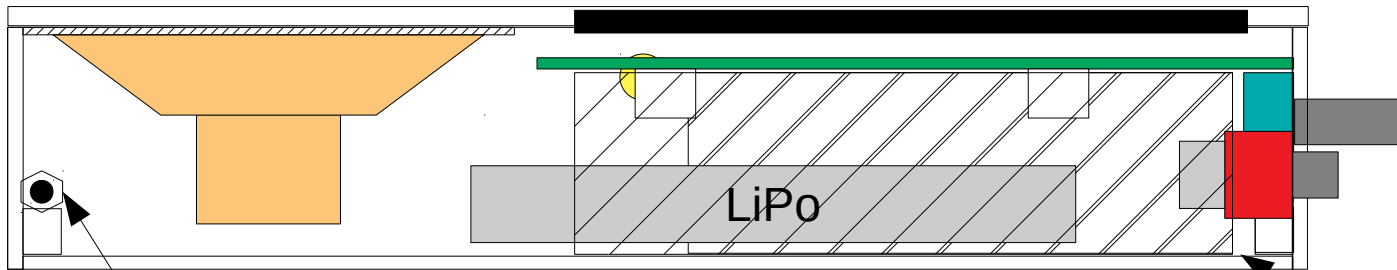

View looking from Bottom.

This Nylon Standoff is on the Top (antenna) side. There is one on the controls end, too.

Glue Board Supports to edges of bottom cover. Leave 8mm from this end.



M3 Nylon Standoffs

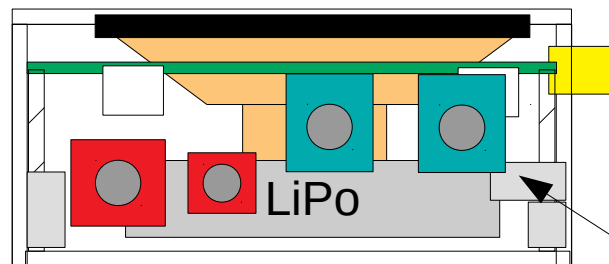

Note Interference. Trim Standoffs as needed.

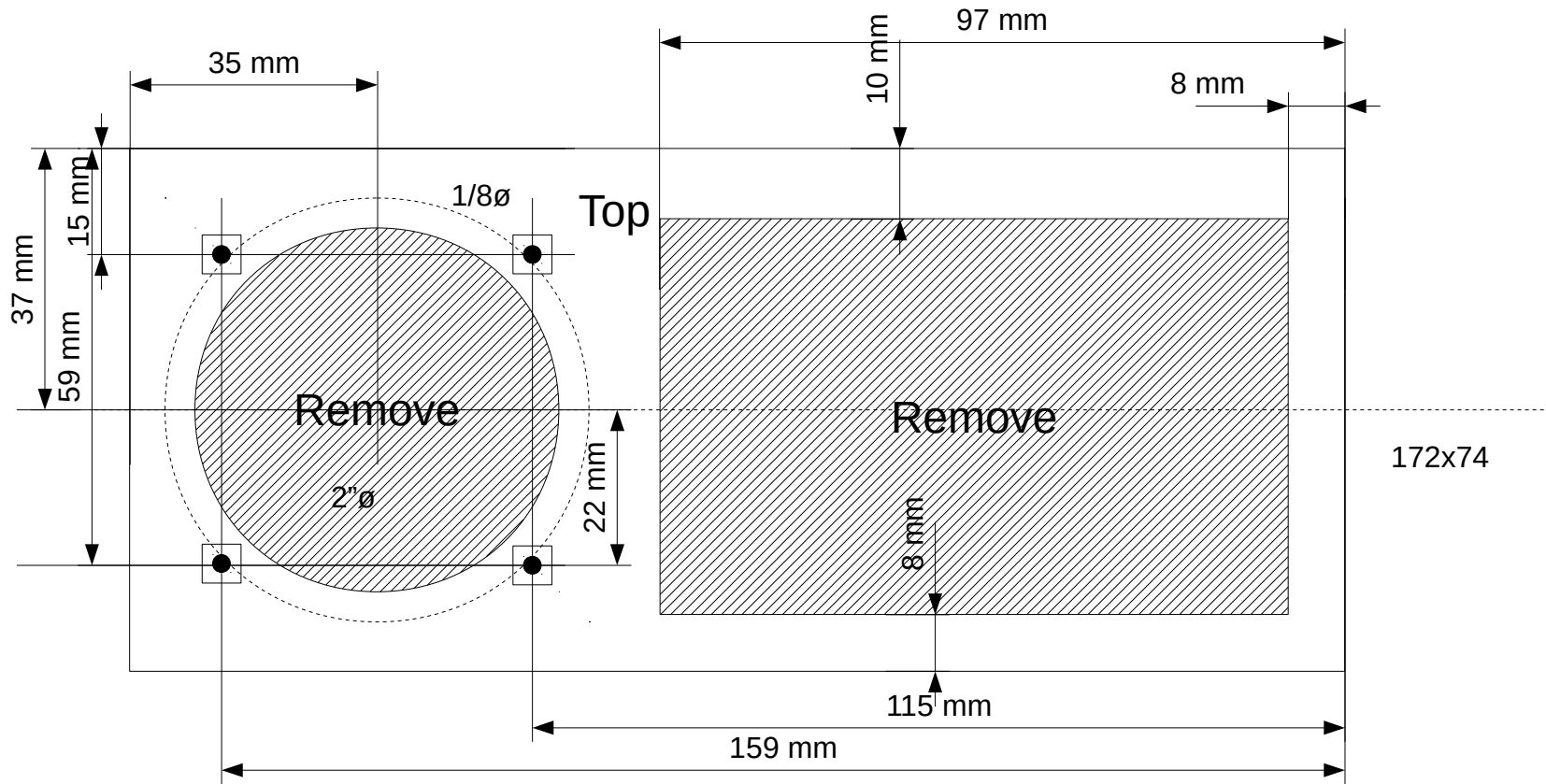

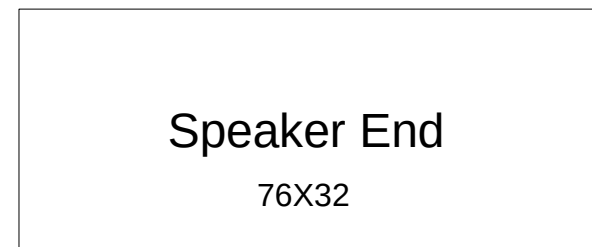
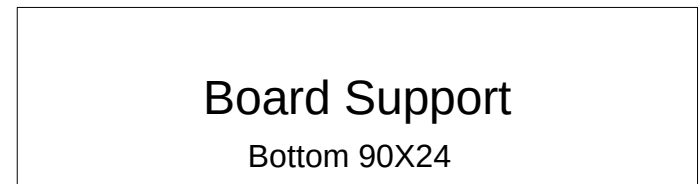
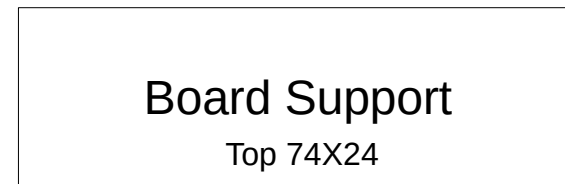
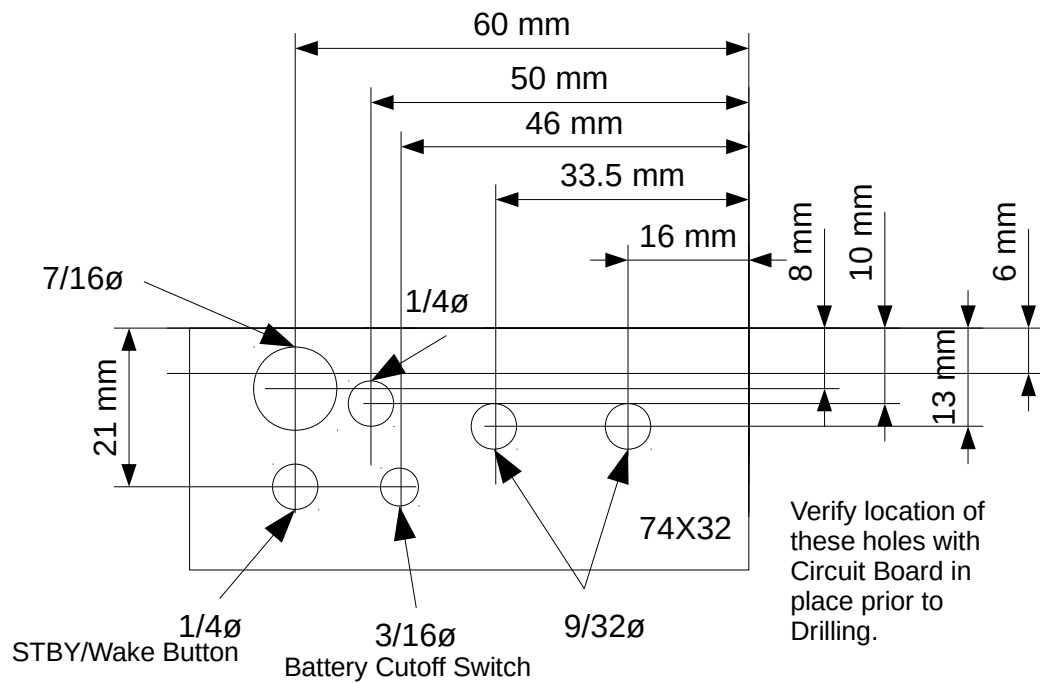
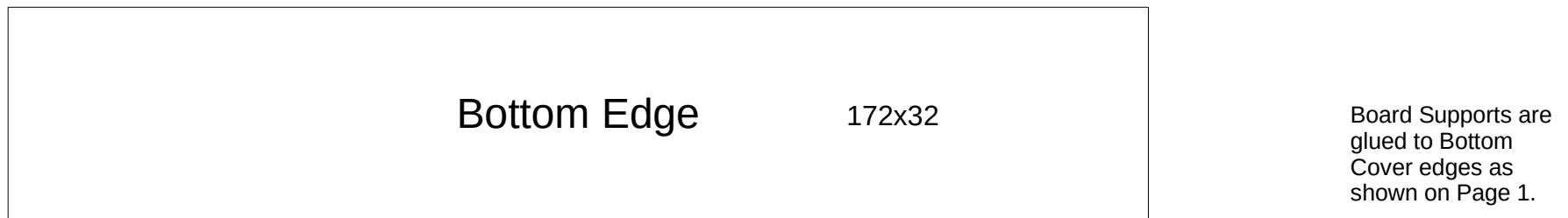
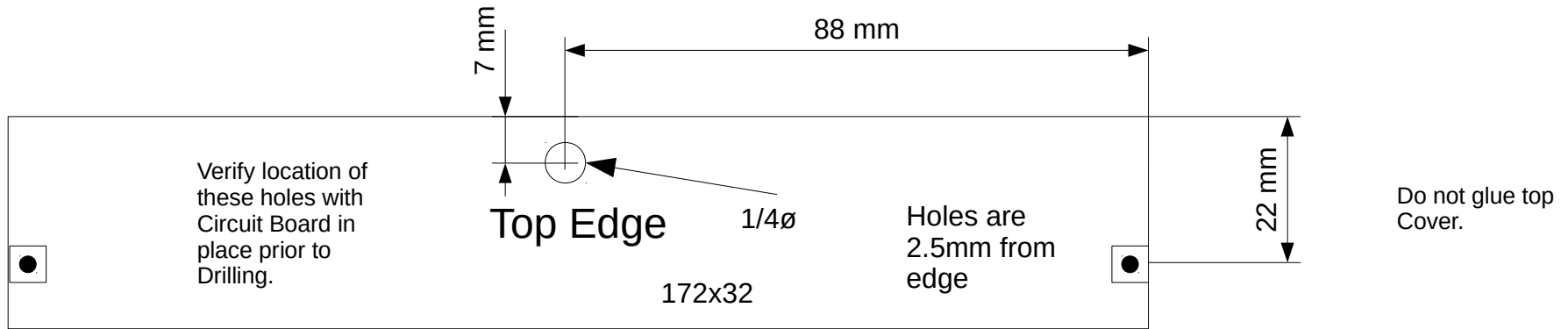

Note: Need Hole to see LEDs.